

**Proton**  
A Distributed Energy  
Systems Company

**UNLV**  
UNIVERSITY OF NEVADA LAS VEGAS

**Hydrogen  
Solar**



# 2005 DOE Hydrogen Program -HYDROGEN FILLING STATION-

**Dr. Robert Boehm, Dr. Yahia Baghzouz**

UNLV Center for Energy Research

**Dr. Thomas Maloney**

Proton Energy Inc.

**Dr. Valerie Self**

Hydrogen-Solar

**Dr. Fred Rattel**

Altair Nanotechnologies Inc.

**Mr. John Tennert**

Las Vegas Valley Water District

**April 22, 2005**

**Project ID #  
TVP8**

This presentation does not contain any proprietary or confidential information

# Overview

## Timeline

- Start-6/12/03
- End-12/31/05
- Percent complete-35

## Budget

- Total project funding
  - DOE \$3,906,604
  - Share \$1,546,246
- FY04: \$1,720,410
- FY05: \$3,732,440

## Barriers

- Barriers addressed
  - Advanced Electrolysis from Renewable Sources
  - Technology Validation

## Partners

- UNLV Research Foundation
- Collaborators
  - UNLV Center for Energy Research
  - Proton Energy (& Air Products)
  - Hydrogen Solar
  - Altair Nanotechnologies
  - Las Vegas Valley Water District

# Objectives

- Show a path to the wide-scale utilization of hydrogen as an energy source
- Validate technology for the renewable generation of hydrogen and its utilization
- Develop advanced techniques for the electrolytic generation of hydrogen
- Bring about cost reductions to all of the above

# Approach

- Develop a renewably powered hydrogen filling station that will serve as focus for a variety of advanced work
- A host organization has been incorporated that will provide vehicles for conversion to hydrogen fuel. These vehicles will utilize the system for on-site testing.
- Advanced H<sub>2</sub> generation processes are being developed, including high pressure electrolysis and tandem solar cells
- Student involvement viewed as important

# 2,000 psi PEM Electrolysis is on Pathway to Lowering H<sub>2</sub> Fueling Costs

5,000+ psig Electrolysis Can Eliminate Need for Compressor  
 2,000 psig Electrolysis Can Eliminate one Compressor Stage

Table PES1 Technical Targets: Water Electrolysis <sup>1</sup>					
Characteristics		Units	2 kg/day Refueling Station Calendar Year 2010		
			Small Scale DOE Target	Estimated Actual for Mechanical Compression	Using 5,000 psi electrolysis(*)
Power Conversion	Cost	\$/kg	0.12	0.12	0.12
	Energy Efficiency	% (LHV)	98	98	98
Cell Stack	Cost	\$/kg	0.30	0.30	0.30
	Energy Efficiency	% (LHV)	79	79	79
Balance of Plant	Cost	\$/kg	0.10	0.10	0.10
	Energy Efficiency	% (LHV)	98	98	98
Compression	Cost	\$/kg	0.09	0.45	0.00
	Energy Efficiency	% (LHV)	93	85	N/A
Storage and Dispensing	Cost	\$/kg	0.12	0.12	0.12
	Energy Efficiency	% (LHV)	99	99	99
Electricity	Cost	\$/kg	2.80	2.87	2.80
	Cost	\$/kg	3.80	4.18	3.71
Total	Energy Efficiency	% (LHV)	70	69.7	70

## Mechanical Compression

- Capital Costs are High
- Lifetime/Durability is Low
- Efficiency is Fair-to-Good
- Only small improvements predicted in near-term

## High Pressure Electrolysis

- Cost Reductions Being done (applies at Low Pressure too)
- Potential for Long Lifetime/Durability
- Potential for High Efficiency

(\*These are estimates to be confirmed when testing and data analyses are complete)

# Photo-Electrochemistry Devices

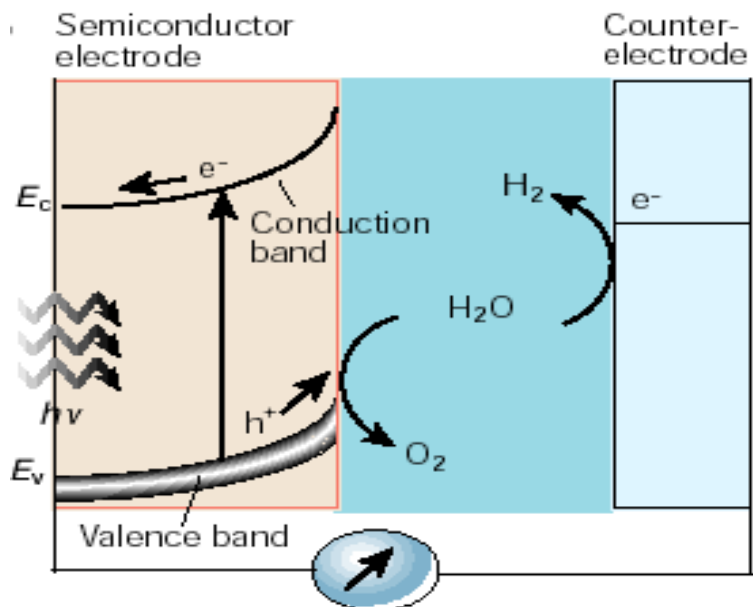

- Light photon absorbed by semiconductor
- Energizes electron from valence band to conduction band
- Energy required is material band-gap (eV)
- Characteristic of the material

- UV light has highest energy (eV)
- Energy above band-gap triggers electron
- Electrons driven away
- Resulting "hole" used for  $O_2$  evolution

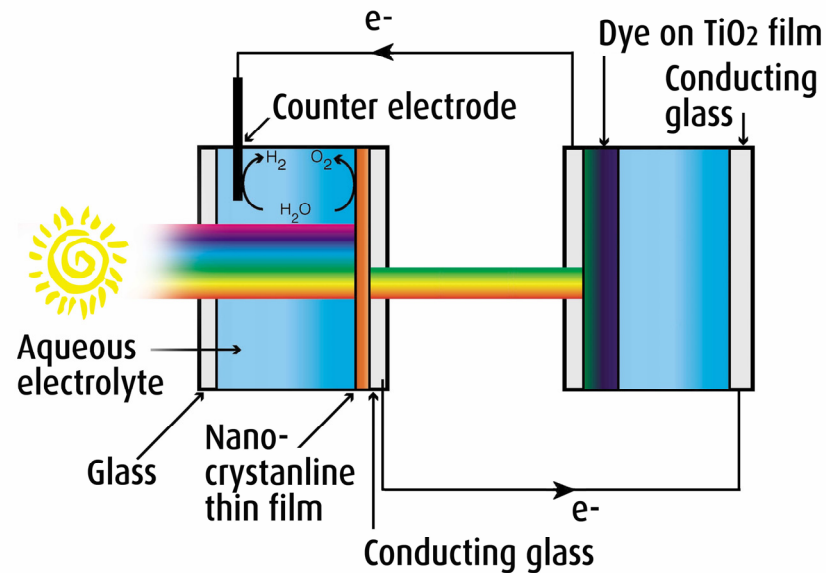

# Hydrogen Safety

***1. The most significant potential hazard is a release of hydrogen due to loss of containment as a result of component failure.***

***This poses two events of about equal severity***

***-Potential for injury due to exposure of a high-pressure (6250 psig) gas stream or debris***

***-Potential for fire upon release of hydrogen***

***2. This potential hazard is being mitigated by the following:***

***-Siting per NFPA 55 requirements (incorporates NFPA 50A)***

***-Hydrogen storage vessels meet the ASME Boiler Pressure Vessel Code Section VIII, Division 1 requirements (Appendix 22)***

***-The hydrogen piping is tested per ASME B31.3 requirements***

***-The PEM electrolyzer meets NFPA 496***

***-No unclassified electrical components (ignition source) within 15 feet of hydrogen storage (motor starters are housed in explosion proof cabinets)***

***-Hydrogen venting per the guidelines of CGA 5.5 – Hydrogen vent systems***

***-Relief valves are appropriately sized and placed at locations where there is a potential for over pressurization. ASME approved relief valves used where mandated***

***(continued on next slide)***

# Hydrogen Safety (cont)

- Predominant connection types are 'medium pressure cone & thread fittings' rated to 20,000 psig*
- Breakaways provided for dispensing hose*
- Dispensing hose has MAWP of 7,700 psig (530 barg) & burst pressure ratio is 6:1*
- Emergency stops (E-stop) available for all the units along with a remote e-stop. Pressing any one e-stop shuts down the operation of entire fueling station*

*The most likely accident scenario for this project comes about from operator/driver error.*

- Driver inadvertently drives away with the fueling nozzle attached to vehicle*
- Driver/Operator smokes near the dispensing area during vehicle fueling*

*The risk associated with this potential accident will be reduced by:*

- Training the vehicle/fueling station operators who fuel the hydrogen-powered vehicles*
- Using a dispensing system with a breakaway on the fueling hose and invoking automatic shutdown should a driver inadvertently drive away with the nozzle connected to the vehicle*
- Requiring a security password to operate the fueling dispenser and requiring that the fueling nozzle interconnects be electronically verified before hydrogen fueling can commence*
- Installing 'No smoking' signs near the dispenser*



# Technical Accomplishments/ Progress/Results

## Basic filling station work

- The hydrogen filling station has been assembled, tested, and is awaiting installation at the site.
- Complete operational and monitoring plans have been developed for the system.
- Incorporation of a high-pressure electrolyzer has been laid out for pad accommodation.
- PV system for driving all has been designed.
- Work on converting two utility vehicles to hydrogen use is well underway.

# Technical Accomplishments/ Progress/Results

## Other work (PEM Electrolysis, TC=Tandem Cell)

- (PEM) Development of a high pressure electrolyzer is underway.
- (TC) Identified materials for light harvesting capability (Fe, W, Ti) for absorbance in range 300-600nm
- (TC) Other materials identified include doped  $\text{TiO}_2$ , CdS, p-type semiconductors for direct hydrogen generation
- (TC) Identified polymer candidates and blends in low and high temperature regimes ( $< 300^\circ\text{C}$  polyphenylene sulphide,  $> 300^\circ\text{C}$  polyimide)





# Technical Accomplishments/ Progress/Results

Other work (PEM Electrolysis, TC=Tandem Cell)

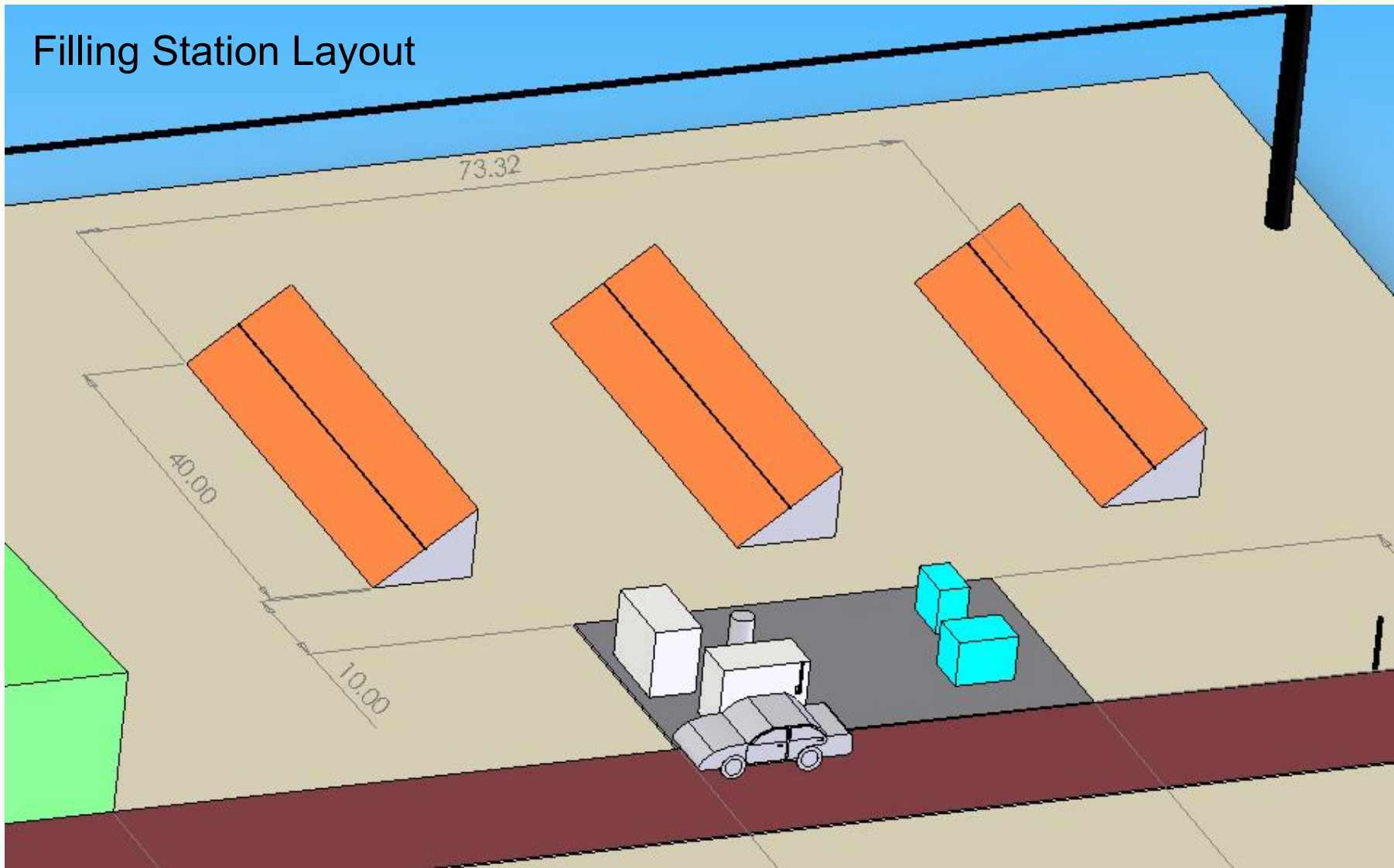
- (TC) Feasibility study performed for in house production of ITO/FTO coated substrates
- (TC) Initial results from CFD study for electrolyte flow and temperature control
- (TC) All equipment for material Altair characterizations has been ordered
- (TC) Nano scale photocatalyst development underway, includes glass electrode deposition at low temperature

## Filling Station Layout



Key:  denotes PV system,  denotes low pressure electrolyzer system,  denotes high pressure electrolyzer system,  denotes existing CNG facility

# Technical Accomplishments/ Progress/Results

- Completed Design for PV-Electrolysis Fueling Station using 200 psig electrolyzer
- Hydrogen Fueling Station Installed and Tested at in-house Site (Wallingford, CT)
- Completed Design for Hydrogen Fueling System that utilizes a 2,000 psig high pressure PEM electrolyzer
- Completed Design for Integrating High Pressure PEM Electrolysis system with Low Pressure Electrolysis Fueling System from Phase I
- Fueling Station Site Plan Completed for Las Vegas Installation



Hydrogen Fueling Station Installed at Proton Energy Systems (Wallingford, CT)

# Pure Electric to Fuel Cell Hybrid Electric Vehicle Conversion

- Electrical System Specifications:
  - Twelve 6V, Deep-cycle, 244 Ah batteries
  - 72V DC motor - 11.5hp @ 4000 rpm normal duty.
  - 400amp, 72V solid-state speed controller
- Fuel Cell Specs.
  - DC power output: 2.5 kW - 5.5 kW max.
  - DC power efficiency: 51%
  - DC Voltage: 100 V @ no-load, 70 V @ full-load.
  - Size: 44x85x75 cm, Weight: 95 kg
  - External power: 300 W @ 48V for start-up.

Taylor Dunn

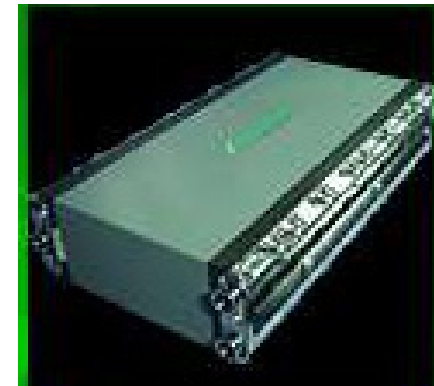



# Fuel Cell Vehicle Preparation



# Block Diagram--Fuel Cell Vehicle

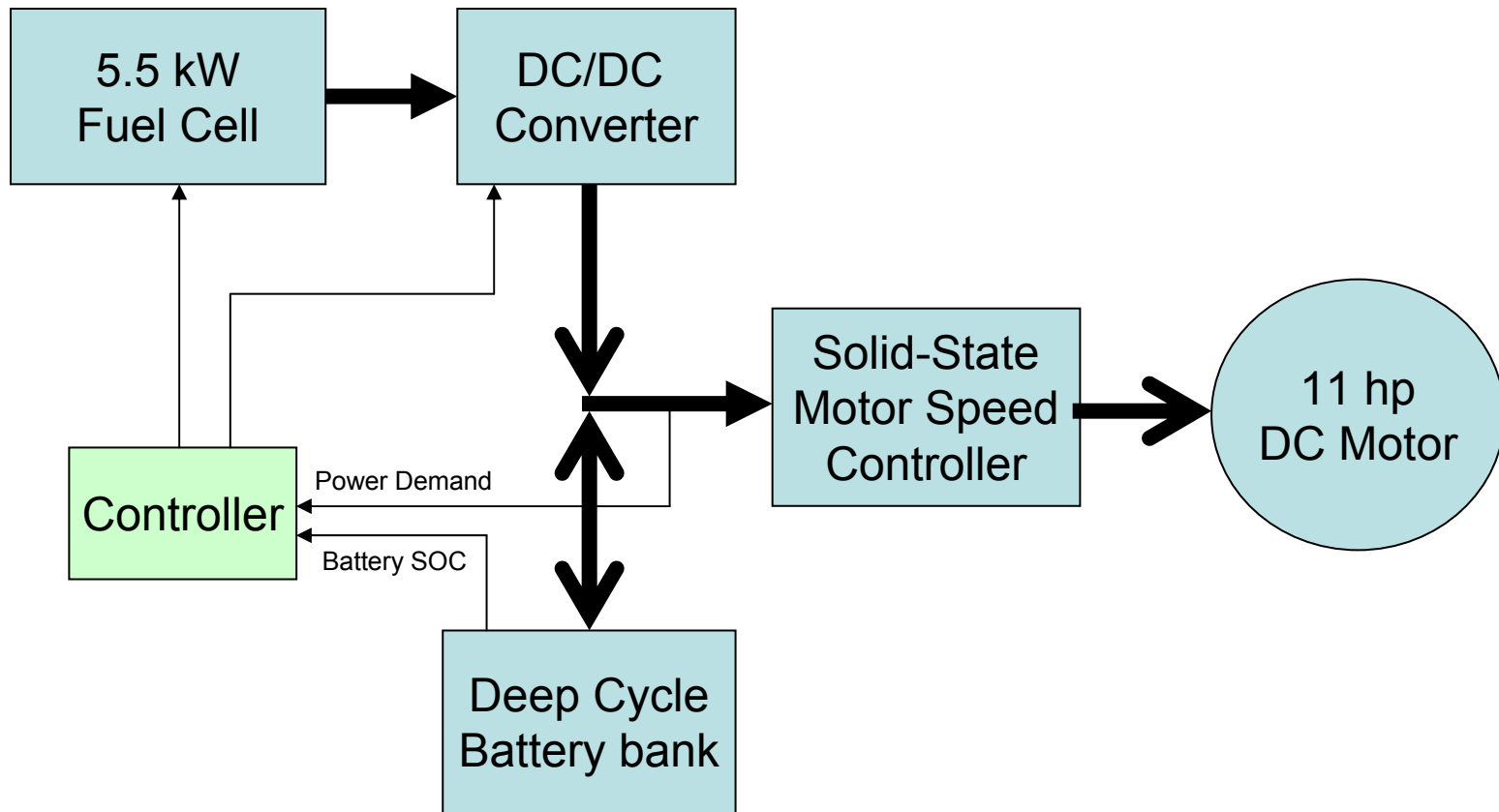



# ICE Vehicle Conversion



QuickTime™ and a BMP decompressor are needed to see this picture.

Engine being converted to direct cylinder injection of H<sub>2</sub>

## Dynetek Products: Cylinders and Systems

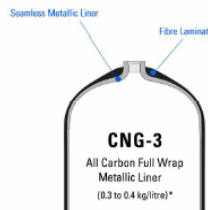

### DyneCell Cylinders

- Lightest CNG cylinder on the market with a metallic liner
- Highest storage capacity of all lightweight designs
- Non-permeable, seamless aluminium liner
- Non-reactive with Hydrogen
- Significantly safer by design
- Very flexible in size configurations
- True fast-fill capabilities
- 5.7 % Wt. Density @ 350 bar

## OPW CLEANENERGY FUELING PRODUCTS



# Laboratory Tandem Cell Test Units

25 cm scale

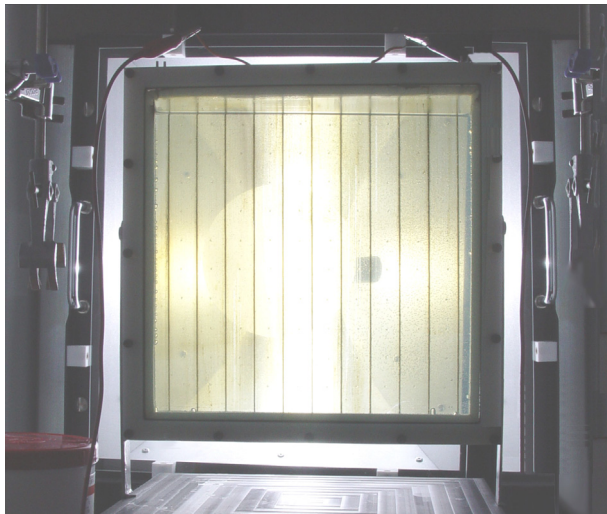
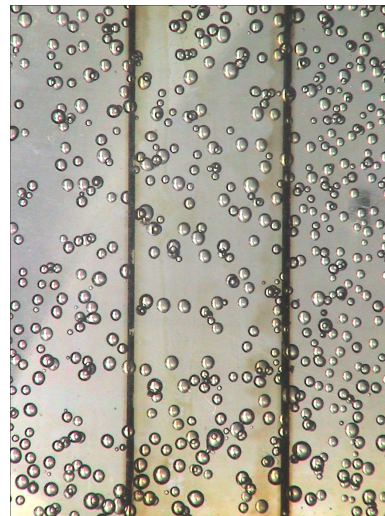
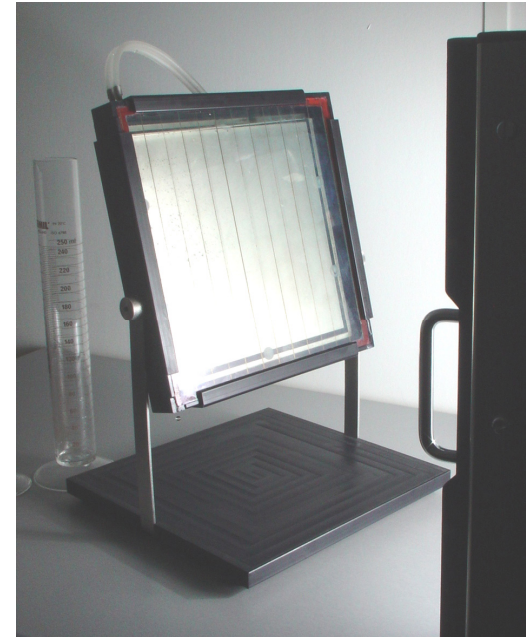

25 cm square Tandem Cell prototypes in  
sunlight from laboratory artificial source

# Structure of Spray Pyrolyzed Films

- SEM  $\alpha$ -Fe<sub>2</sub>O<sub>3</sub> film (x 20,000)

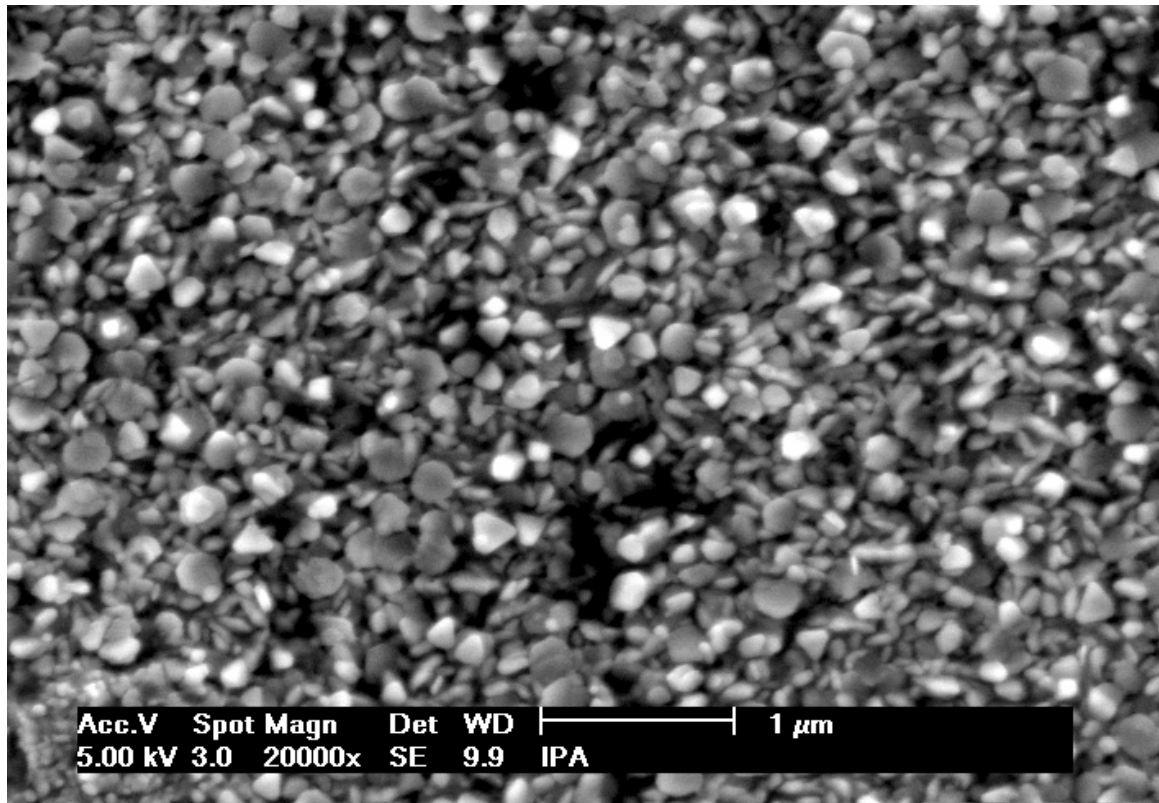

# Glass Substrate UV/visible Spectra (TC)

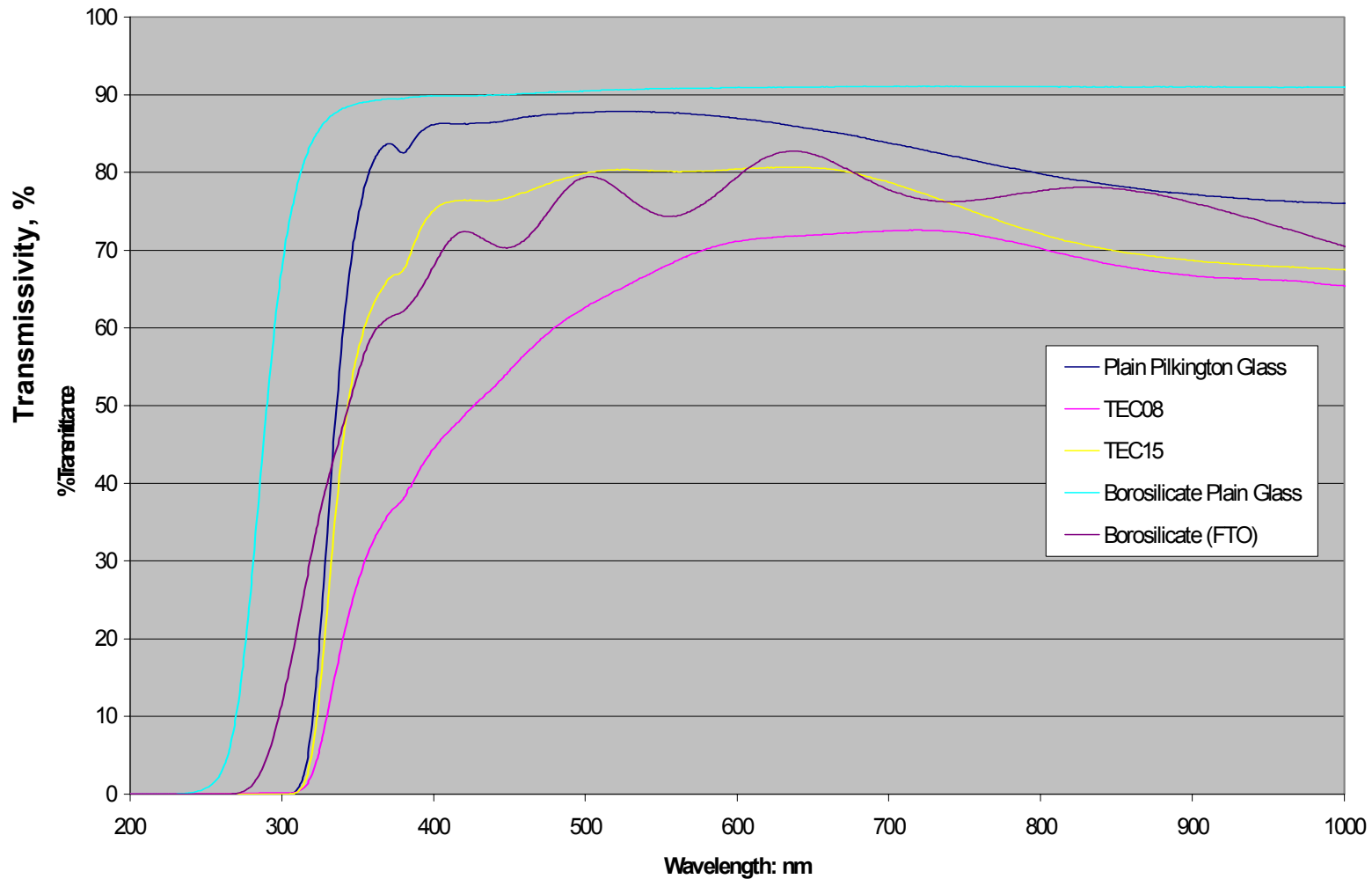

# CFD Modeling of Tandem Cell Electrolyte Flow

Computational Mesh

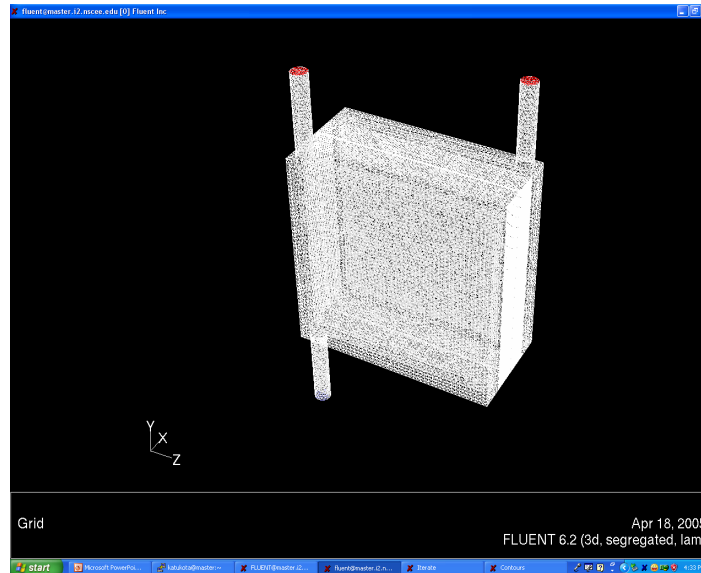

Velocity

Velocity Vectors

Magnitude Contours

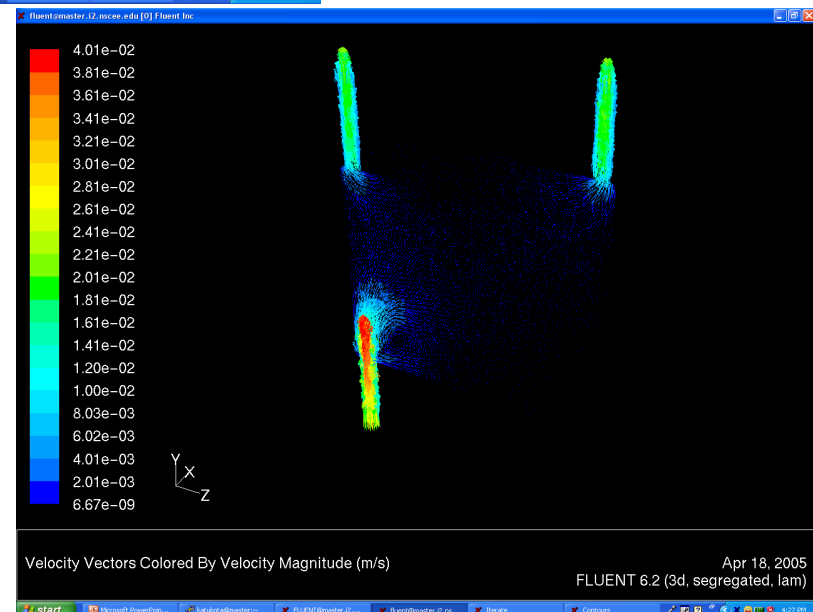
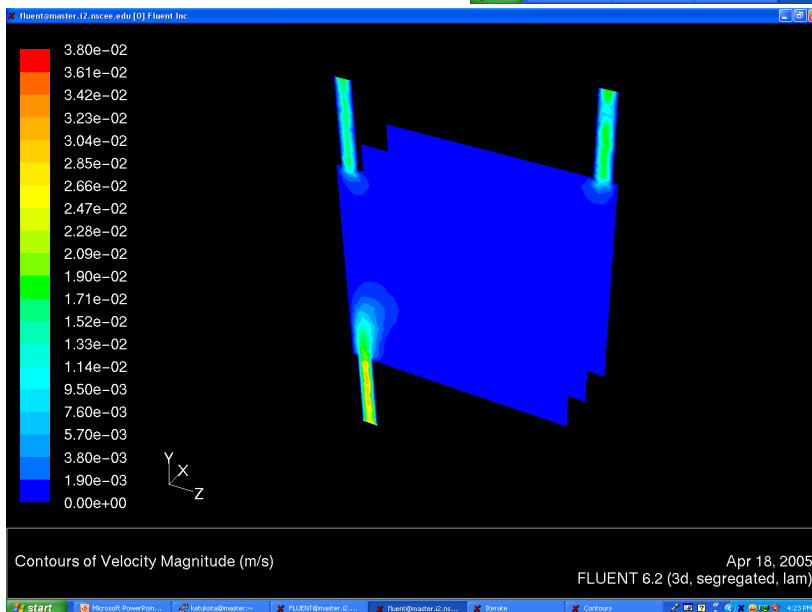



# Responses to Previous Year Reviewers' Comments

- “Better detail desired on poster.” We have attempted to do this here.
- “Three H<sub>2</sub> fueling stations in Nevada not communicating.” Only aware of two in a 400 mile radius. We are attempting to work collaboratively with City of Las Vegas. Our concept is to use model for growing source and demand together.
- “Doesn't know the context of solar H<sub>2</sub>.” Unclear what is meant by this comment.

# Future Work

## FY 05

- Complete the installation of filling station by July 30
- Complete design of high pressure electrolyzer and evaluate performance.
- Complete the vehicle conversions
- Design electrolyte flow configuration in Tandem Cells

## FY 06

- Monitor the general operations of the filling station and the vehicles to see how they perform compared to their design.
- Develop Tandem Cells into a market-ready product.
- Examine new concepts of using inexpensive generation and storage for applications to non-vehicular commercial applications of hydrogen.

# Supplemental Slides

The following three slides are for the purposes of the reviewers only – they are not to be presented as part of your oral or poster presentation. They will be included in the hardcopies of your presentation that might be made for review purposes.



# Sample of 5-Minute Driving Cycle Taylor-Dunn Vehicle

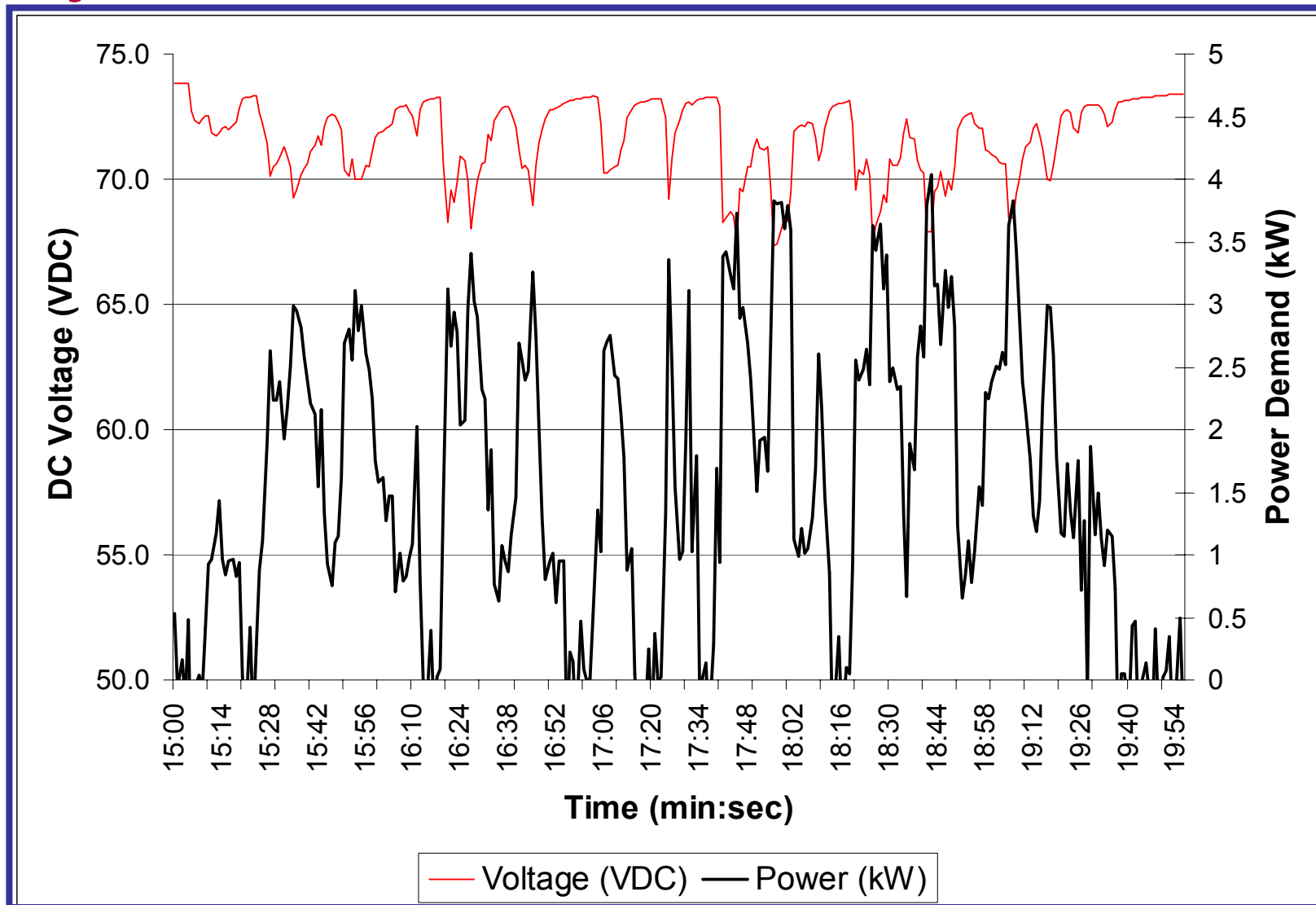

# Publications and Presentations

R. Boehm, Y. Baghzouz, and T. Maloney, "A Strategy for Renewable Hydrogen Market Penetration," 2005 International Solar Energy Conference, Orlando, Florida.

# Some of the Students and Staff of the UNLV Center for Energy Research

